

PARTS DIAGRAM

ENDURA MAX 44

44 LBS THRUST - 12 VOLT - 36" SHAFT

This page provides Minn Kota® WEEE compliance disassembly instructions. For more information about where you should dispose of your waste equipment for recycling and recovery and/or your European Union member state requirements, please contact your dealer or distributor from which your product was purchased.

Tools required, but not limited to: flat head screw driver, Phillips screw driver, socket set, pliers, wire cutters.

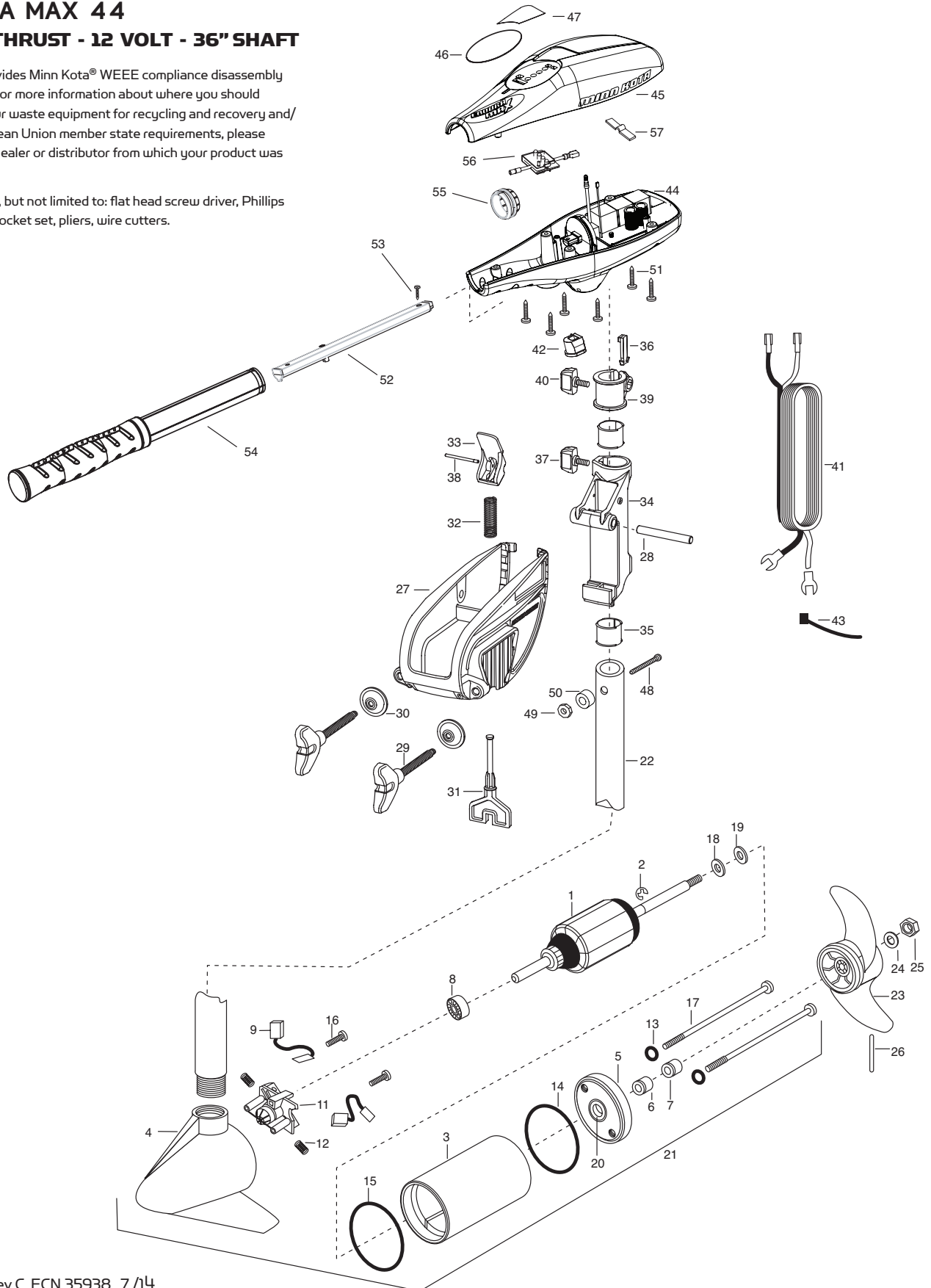

PARTS LIST

ENDURA MAX 44

44 LBS THRUST - 12 VOLT - 36" SHAFT

ITEM	QTY	PART NUMBER	DESCRIPTION
1	1	2-100-202	ARMATURE ASSEMBLY 12V 3.25
2	1	788-015	RETAINING RING
3	1	2-200-079	HOUSING ASSEMBLY CENTER 3.25 TXT
4	1	421-132	BRUSH END HOUSING ASSEMBLY 3.25
5	1	2-400-128	PLAIN END HOUSING ASSEMBLY 3.25
6	1	880-003	SEAL
7	1	880-006	SEAL W/SHIELD
8	1	140-010	BALL BEARING
9	2	188-052	BRUSH ASSEMBLY
11	1	2-600-285	BRUSH PLATE W/HOLDER 3.25
12	2	975-032	COMPRESSION SPRING
13	2	701-007	O-RING – THRU BOLT
14	1	701-039	O-RING
15	1	701-041	O-RING
16	2	830-001	SCREW – SELF THREAD #8-32X1.7
17	2	830-078	THRU BOLT #8-32X8.0
18	1	990-067	WASHER – STEEL THRUST
19	1	990-070	WASHER – NYLATRON
20	1	144-049	FLANGE BEARING (SERVICE ONLY)
21	1	2069288	MOTOR ASSEMBLY 12 V 3.25 VARIABLE SPD
22	1	2032046	36" COMPOSITE TUBE
■	1	1378121	PROPELLER KIT (INCLUDES 23-26)
23	1	2061122	PROPELLER 3.25 HUB DIA
24	1	2151726	WASHER – 5/16 STD SS
25	1	2053101	NUT – PROP NYLOCK (MED) SS
26	1	2092600	DRIVE PIN
■	1	2771818	BRACKET & HINGE ASSEMBLY (INCLUDES 27-38)
■	1	2771910	BRACKET ASSEMBLY (INCLUDES 27, 29, 30)
*27	1	2061910	BRACKET
28	1	2060510	HINGE PIN

ITEM	QTY	PART NUMBER	DESCRIPTION
*29	2	2061300	SCREW – CLAMP
*30	2	2011710	WASHER – CLAMP SCREW
31	1	2063605	PLASTIC T-BAR
32	1	2062706	T-BAR SPRING
33	1	2067201	BLACK TILT LEVER
34	1	2061810	PLASTIC HINGE
35	2	2037301	BUSHING HINGE
36	1	2062800	SNAP-IN TENSION BLOCK
37	1	2011385	SCREW – TENSION/KNOB
38	1	2060515	TILT LEVER PIN
39	1	2061520	DEPTH COLLAR
40	1	2011365	SCREW – COLLAR/NEW KNOB
41	1	2992523	LEADWIRE (WITH 14GA HD SPADE TERMINAL)
42	1	2062905	STRAIN RELIEF
43	1	2026300	TIE WRAP
44	1	2994040	CONTROL BOX
45	1	2060225	CONTROL BOX COVER
46	1	2065719	DECAL COVER ENDURA MAX 44
47	1	2065730	COVER DECAL
48	1	2033401	SCREW – #10-24 X 1-3/4
49	1	2383124	NUT – 10-24 HEX
50	1	2061720	NYLON WASHER
51	6	2012100	SCREW – #8-18 X 5/8
52	1	2990924	INNER HANDLE ASSEMBLY
53	1	2012104	SCREW – #6 X 1/2" SS
54	1	2990913	OUTER HANDLE ASSEMBLY
55	1	2060009	FRONT BEARING
56	1	2074070	BATTERY METER 12V
57	1	2302742	DETENT SPRING - OFF
■	1	2883460	SEAL AND O-RING KIT (INCLUDES 6-7,13-15)

■ THIS ITEM IS PART OF AN ASSEMBLY.

*THIS ITEM IS PART OF A KIT AND ONLY LISTED FOR VIEWING PURPOSES.